

SVANTE ARRHENIUS

## Development of the theory of electrolytic dissociation\*

*Nobel Lecture, December 11, 1903*

At first sight nothing seems more obvious than that everything has a beginning and an end, and that everything can be subdivided into smaller parts. Nevertheless, for entirely speculative reasons the philosophers of Antiquity, especially the Stoics, concluded this concept to be quite unnecessary. The prodigious development of physics has now reached the same conclusion as those philosophers, Empedocles and Democritus in particular, who lived around 500 B.C. and for whom even ancient man had a lively admiration.

Empedocles taught that matter cannot originate from nothing and that matter cannot be destroyed. All happenings in the world are based on a change in form or on the combination or division of substances. Fire, air, water and earth are the four elements of which everything is composed. A continuous cycle is Nature's chief characteristic.

Democritus' theories coincide even more closely with our modern views. He maintained that substances are composed of infinitely small, inseparable particles, which he called atoms. These vary in shape and size and yield different products according to the differing ways in which they are combined together.

This theory of the atoms was resuscitated by Gassendi in about 1650 and later adopted by Boyle and Newton. It attained its present great importance owing to Dalton's discovery of the law of multiple proportions. For example, the various compounds of nitrogen and oxygen contain 0.57, 1.14, 1.72, 2.29 or 2.86 parts by weight of oxygen per part by weight of nitrogen. There are no transitional forms between these compounds. To account for this phenomenon we assume, in common with Dalton, that the molecule of the various nitrogen and oxygen compounds contain two atoms of nitrogen and 1, 2, 3, 4 or 5 oxygen atoms. This is specific to chemistry in contrast with physics where the simpler, continuous transition from one state to another usually

\*This paper has previously been published in English in the *Proceedings of the Royal Institution*, 1904.

applies. This dissimilarity between the two sister-sciences has frequently led to differences of opinion in physical chemistry. That discontinuous changes and multiple proportions also occur in physics has been assumed in many cases which, on closer examination, disproved this assumption.

The law of multiple proportions is one of the foundations on which modern chemistry is built. Another such is Avogadro's law which states that equal volumes of different gases at the same temperature and pressure contain the same number of molecules. This theory, which dates from the beginning of the nineteenth century, first met with strong opposition and it was its great value in explaining the new discoveries within the rapidly expanding field of organic chemistry that resulted in its universal adoption in the middle of last century after Cannizzaro had acted vigorously in its favour.

Meanwhile there were certain problems to be overcome before Avogadro's law could be accepted. It was found, for example, that the molecular volume of ammonium chloride,  $\text{NH}_4\text{Cl}$ , in the gaseous state is greater than would be supposed on the basis of its chemical composition. This led to the assumption that the molecules of  $\text{NH}_4\text{Cl}$  in the gaseous form are partly broken down into ammonia,  $\text{NH}_3$ , and hydrochloric acid,  $\text{HCl}$ . Von Pebal and Von Than were able to prove that this does in fact occur. They used an apparatus shown in Fig. 1. Two tubes were placed one inside the other by means of a cork. The outer tube was sealed at its open end; the inner tube was open and contained at C, on top of an asbestos partition, a piece of  $\text{NH}_4\text{Cl}$ . The top was heated in an air bath so that the piece of  $\text{NH}_4\text{Cl}$  slowly volatilized. At the same time a stream of hydrogen was admitted through the two glass tubes D and E. Ammonia diffuses through porous walls at a faster rate than the hydrochloric acid. If the  $\text{NH}_4\text{Cl}$  gas partly breaks down in this way to form ammonia and hydrochloric acid, it is reasonable to expect that there should be an excess of the latter above the porous asbestos partition and an excess of ammonia below it. Von Pebal showed this to be so. The stream of hydrogen from D gave an acid reaction with litmus paper at A, and the stream from E gave an alkaline reaction, likewise on litmus paper, at B. It was then objected that the breakdown might be caused by the asbestos partition or by the hydrogen. Von Than therefore made a partition of  $\text{NH}_4\text{Cl}$  and replaced the hydrogen by nitrogen, but with the same result.

These experiments were performed in 1862 and 1864. They were based on the theory of dissociation which had been worked out in 1857 by Sainte-Claire-Deville and elaborated by his pupils. From time immemorial use has been made of the fact that at high temperature limestone gives off carbon

dioxide to form quicklime. This and similar processes were studied by Sainte-Claire-Deville. He found that the same law applies to the pressure of carbon dioxide above limestone as to the pressure of water vapour above evaporating water at different temperatures. These fundamental studies are basic to the theory of dissociation which has since played an increasingly important part in chemistry and, in a manner of speaking, created a wide bridge between the physical and chemical sciences.

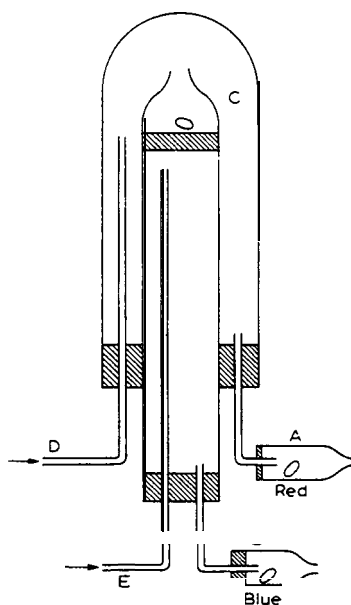

Fig.1.

At almost the same time we find in Clausius' work on the electrical conductivity of salt solutions the first inklings of an idea that salts and other electrolytes are capable of partial dissociation when dissolved in water. Buff had found that even the least electrical force is sufficient to drive a current through a salt solution. According to Grotthus' conception, which at that time was generally accepted, the electrical current passes through a solution in such a way that the conducting molecules, e.g. of potassium chloride (KCl), separate into their ions, which recombine in the following manner. Firstly, when the current sets in, the pole A becomes positive and the pole B negative. All the conducting KCl molecules arrange themselves with their positive K ions turned towards the negative pole B and their negative Cl ions

towards the positive pole A. Next a chlorine ion is liberated at A and a potassium ion at B, and the other ions combine again, the K ion in the first molecule capturing the Cl ion in the second molecule, and so on (Fig. 2). The molecules then turn under the influence of the electrical force to give us stage 3 and splitting can take place anew. That is Grotthus' view; it presupposes continuous splitting and recombination of the salt molecules.

Since these exchanges of ions between the molecules take place under the influence of the least electrical force, Clausius concluded that they must occur also when there is no electrical force acting, in other words, irrespective of

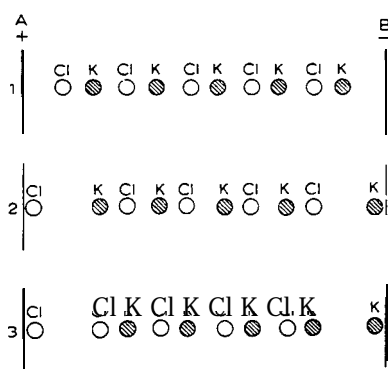

Fig.2.

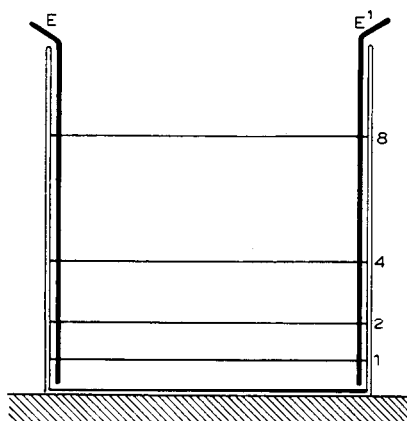

Fig.3.

whether current passes through the liquid. In support of this hypothesis he pointed out that in fact as early as 1852 Williamson, in his epoch-making theory of the formation of esters, assumed a similar exchange of constituents between the molecules. Clausius held that during the exchange of ions it would sometimes, although extremely rarely, occur that an ion remained free in the solution for a short time. At least, such an assumption is quite consistent with the mechanical theory of heat as developed at that time by Krönig, Maxwell, Clausius and others.

Meanwhile Bouty and particularly Kohlrausch devised methods to determine the electrical conductivity of salt solutions. In 1884 I gave a paper dealing with this subject. I had found that if a solution of, say, zinc sulphate is diluted, its conductivity per molecule, or what is termed its molal conductance, does not increase infinitely but only as far as a certain limit. We can visualize an experiment carried out in the following manner (Fig. 3). In-

to a parallel-walled vessel are inserted very close to two opposite sides two amalgamated zinc plates, E and E'. A layer of zinc sulphate solution is introduced extending from the horizontal bottom of the vessel to the line 1. The conductivity is assumed now to be  $k_r$ . After this has been measured, sufficient water is added so that after the solution has been stirred the level reaches 2 which is as far above 1 as 1 from the bottom. The conductivity is then found to have increased and have a value  $k_2$ . When the volume is

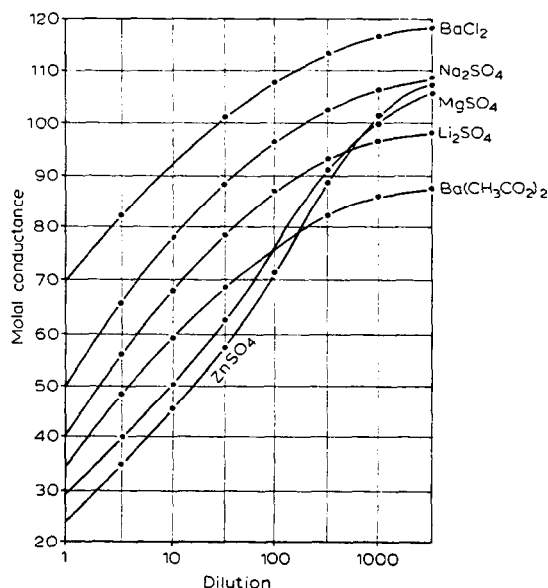

Fig.4.

doubled in the same way by the addition of pure water, level 4 is reached and the conductivity is greater than in the foregoing case, let us say  $k_4$ . We can continue in this way and the conductivity increases but ultimately at a lower rate than at the beginning. A final value of  $k_\infty$  is thus reached. This is best illustrated by the following diagram which shows Kohlrausch's more recent determinations (Figs.4 and 5). Here the dilutions are the abscissa and are given in gram-equivalents per litre. The molal conductance at 18°C is the ordinate and given in thousandths of units (ohm).

I explained these experimental results in the following manner. The conductance is governed by the rate at which the ions ( $Zn$  and  $SO_4$ ) of the molecules ( $ZnSO_4$ ) are carried through the liquid by the electrical force, i.e. the potential difference between E and E'. If this potential difference is as-

sumed constant, the rate is determined solely by the friction which the ions during their passage through the liquid set up on the surrounding molecules. Since at strong dilutions these are almost exclusively water molecules, there is reason to suppose that the molal conductance will remain constant and independent of the dilution, assuming of course, that all  $\text{ZnSO}_4$  molecules participate in the conduction of the electricity. As the experiment now shows that the molal conductance increases with the dilution to a very high value -

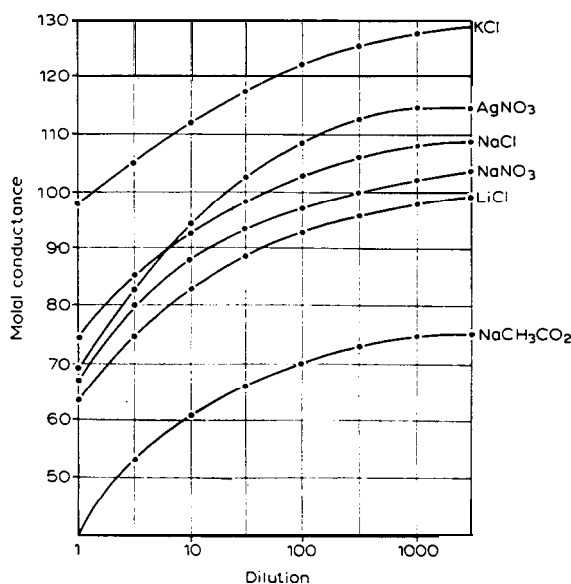

Fig. 5.

1,000 water molecules or more to each molecule of  $\text{ZnSO}_4$  - we arrive at the hypothesis that not all but only some of the  $\text{ZnSO}_4$  molecules participate in the conduction of the electricity. This participation grows with the dilution in the same ratio as the molal conductance  $k$ . With continuously increasing dilution, the molal conductance approximates more and more to the limit value  $k_\infty$  which is the point at which all molecules conduct electricity. The conducting part of the molecules is termed the active part. It can clearly be calculated as the quotient of  $k : k_\infty$ .

If this concept had only been applicable to accounting for the phenomenon of electrical conductivity, its value would not have been particularly great. An examination of the numerical values adduced by Kohlrausch and others for the electrical conductivity of acids and bases as compared with Berthelot's

and Thomson's measurements of their relative strengths in terms of their chemical effect showed me that the acids and bases with the greatest conductivity are also the strongest. I was thus led to the assumption that the electrically active molecules are also chemically active, and that conversely the electrically inactive molecules are also chemically inactive, relatively speaking at least. In this connection I would like to mention Gore's remarkable experiment which can readily be explained by the new concept. Concentrated hydrochloric acid, which is free from water, has no effect on oxides or carbonates. It happens that hydrochloric acid in this form is very nearly incapable of conducting electrical current whereas its aqueous solutions have very good conductivity. The pure hydrochloric acid thus contains no active molecules, or extremely few, and this agrees very closely with Gore's experiment. In the same way we can explain the fact that concentrated sulphuric acid can be stored in a sheet iron vessel without damage to the latter, although this is impossible with the dilute acid.

An unexpected conclusion may be drawn from this concept. Because all electrolytes in an extremely dilute state are completely active, the weak acids must increase in strength when diluted and approach that of the strongest acids. Shortly afterwards this proved to be in agreement with the experiments carried out by Ostwald.

The Norwegian research scientists Guldberg and Waage had developed a theory according to which the strength of different acids could be measured by their capacity of displacing, in solutions, another acid as well as by their capacity of increasing the speed of certain chemical reactions. In conformity with this we can suppose that the speed of a reaction produced by an acid is proportional to the number of active molecules in it. I had only a few experiments by Berthelot to demonstrate this law, but in 1884 Ostwald published a large number of observations which proved that this conclusion was correct.

The most far-reaching conclusion from the conception of active molecules was the explanation of heat of neutralization. As it is much simpler to understand this by means of the theory of electrolytic dissociation, I will therefore anticipate it for this case. According to this theory strong acids and bases, as well as salts, are in extreme dilution almost completely dissociated into their ions, i.e. HCl into  $H^+$  and  $Cl^-$ , NaOH into  $Na^+$  and  $OH^-$ , and NaCl into  $Na^+$  and  $Cl^-$ . On the other hand, water is hardly dissociated at all. The reaction of neutralization of a strong acid with a strong base, e.g. HCl with NaOH, both greatly diluted, can therefore be expressed by the following equation:

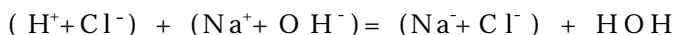

or

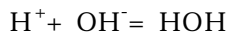

This equation is equivalent to the formation of water from its two ions,  $H^+$  and  $OH^-$ , and is evidently independent of the nature of the strong acid and the strong base. The development of heat in any reaction of this kind must therefore always be the same for equivalent quantities of any strong acids and bases. Actually, it has been found that in every case this is 13,600 calories (at  $18^\circ C$ ). This constancy of neutralization heat is the most law-abiding phenomenon which has been discovered in thermochemistry.

The question now arose in what respect the active state of the electrolytes differs from the inactive state. I gave an answer to this question in 1887. At this time Van 't Hoff had formulated his far-reaching law that the molecules in greatly diluted solutions obey the laws which apply to the gaseous state if gas pressure in liquids is merely replaced by the osmotic pressure. As Van 't Hoff demonstrated, the osmotic pressure of a solute can be far more easily determined by measuring the freezing point of its solution than directly. However, both the direct measurements carried out by De Vries and the freezing points of electrolytic solutions showed a much higher osmotic pressure than would have been expected from the chemical formula. For instance, whilst the solution of one gram-molecule (mole) of ethyl alcohol,  $C_2H_5OH = 46$  grams, in one litre of water gives a freezing point of  $-1.85^\circ C$ , according to Van 't Hoff's calculations a solution of one mole of sodium chloride,  $NaCl = 58.5$  grams in one litre of water gives a freezing point of  $-3.26^\circ C = -1.75 \times 1.85^\circ C$ . This characteristic could be explained in the same way as the "abnormal" density of gaseous ammonium chloride, i.e. by supposing a partial dissociation - up to 75% - of the sodium chloride molecules. On this assumption, therefore, the solution contains 0.25 moles of  $NaCl$ , 0.75 moles of  $Cl$  and 0.75 moles of  $Na$ , a total of 1.75 moles, and has a corresponding effect regarding the depression of the freezing point. We have seen in what way we can calculate from the electrical conductivity the number of active molecules in the same solution of sodium chloride, and from Kohlrausch's measurements we find exactly the same number, i.e. 0.75. This strengthens the conception that the active molecules in the salt  $NaCl$  have split 'up into the ions  $Na^+$  and  $Cl^-$ . These are absolutely free and they appear in the solutions exactly like other molecules. In the same way I cal-

culated by both methods the degree of dissociation in all the electrolytes which had been determined at the time-there were about 80 of them-and I found that there was a very good agreement between the two different methods of determination. In some cases the agreement was not so good and I therefore carried out new analyses of these bodies and some others. The new analyses were all completely in agreement with the theoretical assumptions.

Fig. 6 shows the freezing points of some solutions of salts and non-conductors. The abscissa of the diagram shows the concentration of the bodies in the solutions, while the ordinate shows the molecular depression of the

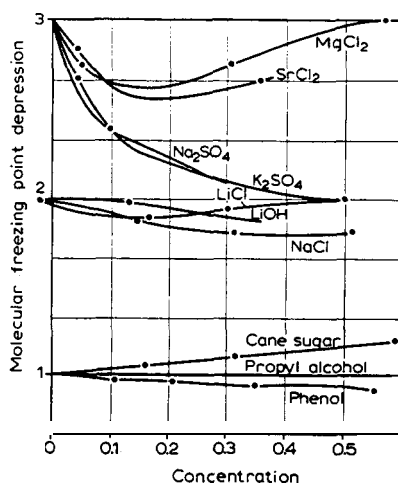

Fig. 6.

freezing point divided by 1.85. The figure shows us that all the curves of the non-conductors - in this instance cane sugar, propyl alcohol and phenol-converge towards unity with decreasing concentration as one would expect, since no dissociation takes place. With higher concentrations variations from the simple law take place. As examples of electrolytes consisting of two ions, LiOH, NaCl and LiCl have been selected; their curves all converge towards value 2. As electrolytes consisting of three ions K<sub>2</sub>S0<sub>4</sub>, Na<sub>2</sub>S0<sub>4</sub>, MgCl<sub>2</sub> and SrCl<sub>2</sub> have been selected; all these curves converge on value 3 for great dilution.

As I had accepted this explanation, which seemed to chemists to be most adventurous, I had to investigate whether it would agree chemically and physically with experience obtained. The most general and far-reaching point of all this is that the properties of a highly diluted electrolytic solution

are composed of the different ions of which the electrolyte consists. It was already known that this was the case in many instances, and Valson had for this purpose drawn up tables of their so-called moduli. By comparing the one modulus value-for the negative ion-with the other - for the positive ion - we can calculate the properties of each of the electrolytes consisting of the ions in the table. In this way we can deal with the specific weight (Valson), the molecular conductivity (Kohlrausch), the internal friction (Arrhenius), the capillary attraction (Valson), the compressibility (Röntgen and Schneider), the refraction exponent (Gladstone), the natural polarization rotation (Oudemans), the magnetic polarization rotation (Perkin and Jahn), the magnetism (Wiedemann) and all the other properties of the electrolytes which have so far been adequately studied.

The most significant of these properties are those we use in chemical analysis. As is well-known, it is in general true that chlorides yield a white deposit (silver chloride) with silver salts. It used to be said, therefore, that silver salts were reagents for chlorine. Now we say that silver ions are reagents for chlorine ions. This expression is better than the older one, as indeed some such silver salts, e.g. potassium silver cyanide and many other silver compounds which do not contain silver ions, on the one hand, and all chlorine compounds, e.g. potassium chlorate and many organic chlorides which do not contain chlorine ions, on the other hand, do not give this characteristic reaction. The experiment succeeds only with such silver and chlorine compounds which are split to a noticeable degree into silver and chlorine ions. Ostwald has dealt comprehensively with this question and in this way has produced a rational presentation of the general phenomena of analytical chemistry. To this sphere there also belongs the poisonous effect of certain salts, which can be regarded as a separate physiological-chemical reaction of the chemical compounds. In this connection there are the valuable investigations by Krönig and Paul, Clarke and others.

A property of a physical nature, but one which is very much used by the analytical chemist, is the colour in solutions. This has been thoroughly investigated by Ostwald. First let us see how a chemical compound, e.g. fluorescein,  $C_{20}H_{12}O_5$ , behaves if its hydrogen atoms are replaced by other atoms, e.g. by metals, iodine, bromine or by atom groups (NO<sub>2</sub>). The curves in the next figure, Fig. 7, represent the absorption bands in the spectra for the respective compounds. If H<sub>2</sub> is replaced in the fluorescein itself by K<sub>2</sub>, the absorption spectrum is very greatly changed.

This is due to the property of fluorescein to be dissociated to a very slight

degree. (Permanganic acid behaves quite differently, as we shall soon see.) Instead of a single absorption band in the blue field of the fluorescein spectrum we find two absorption bands in the blue-green and the green regions in the spectrum of its salts, which all behave like potassium salt in that they are all dissociated into metal ions and fluorescein ions, among which only the latter are optically active.

A similar observation can also be made in the case of tetraiodo-fluorescein and its potassium salt. In general the figures show that the spectrum undergoes instantaneous change when even the slightest chemical change takes place in the molecule.

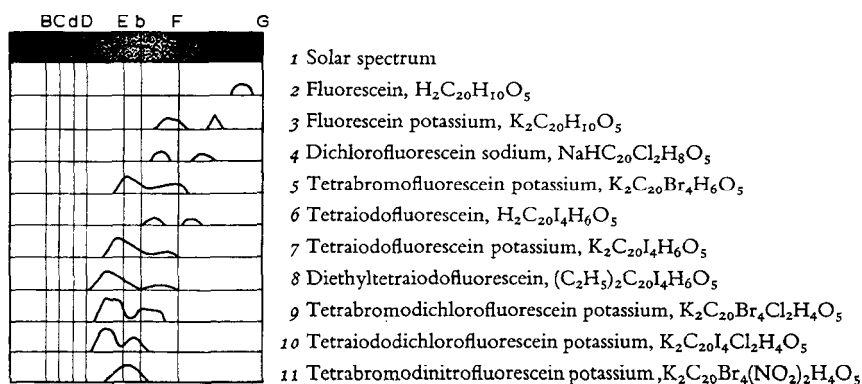

Fig.7. Fluorescein derivatives.

Thus, on the basis of existing theories we should expect that exchange of hydrogen with a metal in permanganic acid or of one acid residue with another in salts of pararosaniline will change entirely the nature of the absorption spectrum. As Ostwald has shown, this is not the case. The spectrum is quite unchanged, as will be seen from Figs. 8 and 9. The spectra are represented by the same substance, that is to say, in the one case by a permanganic-acid ion and in the other by a pararosaniline ion. In the case of the pararosaniline ion, however, it will be seen that the absorption is clearly less pronounced than in the case of the permanganic-acid ion. Its background has weakened in so-called hydrolysis of the salts of weak acids, e.g. acetic and benzoic acids. Ostwald's investigations of the "coloured" ions give a particularly striking example of the applicability of the ideas underlying the theory of electrolytic dissociation.

It has been noted in connexion with this theory that it should be possible

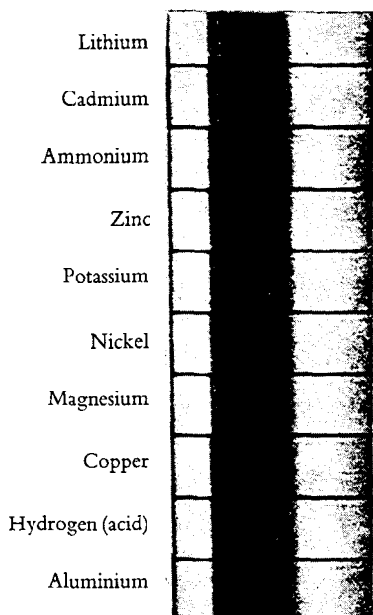

Fig. 8. Permanganates.

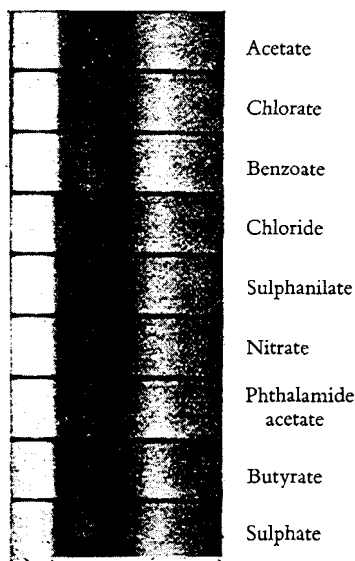

Fig. 9. Pararosaniline salt:

according to it to separate by diffusion both ions, for instance the chlorine and sodium ions in sodium chloride solutions. In actual fact the chlorine ion diffuses about 1.4 times as rapidly as the sodium ion. But ions take their electrical charges with them. If therefore we pour a solution of sodium chloride into a vessel and carefully cover it with a layer of pure water, immediately a small surplus of chlorine will enter the water. Thus the water becomes negatively charged and the solution beneath it positively charged, so that the positive sodium ions are driven out of the solution under a greater force than are the negative chlorine ions. As soon as the former forces become 1.4 times as great as the latter forces the velocity of the chlorine ions becomes the same as that of the sodium ions. It is not difficult to work out that this occurs as soon as the chlorine-ion content in the water exceeds the corresponding quantity of sodium ions by about one billionth of a milligram. It would be useless to try to determine this extremely small amount by chemical methods; on the other hand it can easily be determined electrically, as Nernst has shown in experiments for his concentration elements. Thus this objection is valid only in the case of hypotheses concerning a general dissociation of salts and not dissociation into ions, which are charged with electricity in accordance with Faraday's law. This objection has prob-

ably been a stumbling block for an earlier assumption concerning the state of dissociation of electrolytes, which numerous investigators, e.g. Valson and Bartoli have been inclined to support.

The gas laws, which apply to dilute solutions, have in a large number of cases made it possible to calculate degrees of dissociation. The first investigator to use this principle was Ostwald, who showed that dissociation equilibria between ions and the undissociated parts of a weak acid more or less obey the laws that apply to gases. Bredig has since shown that the same relationship is found in the case of weak bases. But highly dissociated electrolytes, in particular salts, display deviations from dilute solutions (above 0.05 normal) which as yet have not been fully explained. Professor Jahn in Berlin is at present studying this very interesting question.

The equilibrium between a large number of electrolytes has been studied by me, and has been found to agree well with the values obtained on the basis of the dissociation theory. This field of research covers problems concerning the weakening of acids through addition of one of their salts, and the so-called avidity of acids, that is to say the ratio in which two competing acids divide a base. The results of calculations largely confirm the experimental findings of Ostwald and Thomson in this field. Theories concerning the heterogeneous equilibrium ratios between electrolytes have been put forward by Van't Hoff and Nernst, who in this way have thrown light on the general method used to precipitate salts in analytical chemistry.

It is also possible with the aid of the gas laws to determine the heat evolution that takes place during the dissociation of a weak acid or base, and in this way I have been able in general to calculate the heat evolution that takes place when acids are neutralized by bases. In a similar way Fanjung calculated the volume changes that take place on the dissociation of a weak acid or base and on neutralizing these substances. All these calculations have given values that agree closely with those observed in reality.

Water, which can be regarded as a weak acid or base, plays an important role. Through its electrolytic dissociation it brings about hydrolysis of the salts of weak acids and bases. It has been possible, through observation of the extent of the hydrolysis, to calculate the extent of the electrolytic dissociation of water, and when this was determined shortly afterwards by Kohlrausch and Heydweiller by means of electrical measurements, there was found to be complete agreement with the earlier calculations. These questions are of the utmost importance for physiological chemistry, as has been shown by the results obtained in the investigations of Sjöqvist and others. In

studying volcanic phenomena, too, the competition between water and silicic acid at different temperatures has proved useful.

The phenomena of catalysis, in which acids or bases play a leading role, have been studied by many investigators, and it has been found that catalytic action depends on the large number of free hydrogen or hydroxyl ions present in solutions.

In this survey, which does not claim to be a comprehensive one, mention should also be made of the exhaustive investigations of Van 't Hoff, Ostwald and in particular Nernst into the electromotive force of ions. These investigations have shed new light on the old problem of the way in which electrical forces are produced in hydro-electric combinations.

I have now described how theories of electrical dissociation have developed from our old ideas about atoms and molecules. We sometimes hear the objection raised, that this viewpoint is perhaps not correct, but only a useful, substituting working hypothesis.

This objection is in fact not an objection at all, for we can never be certain that we have found the ultimate truth. Theories of molecules and atoms are sometimes attacked on philosophic grounds. Until a better and more satisfactory theory appears, chemists can continue to use the atomic theory with complete confidence. The position is exactly the same as regards electrolytic dissociation.

This theory has also shown us that atoms or groups of atoms charged with electricity play a highly significant part in the world of chemistry. The general tendency in scientific research appears to be to attach more and more importance to electricity, the most powerful factor in nature, and developments in this direction are now proceeding very rapidly. We have already seen not only how J. J. Thomson's electron theory, in which matter is reduced to a very insignificant part, developed, but also the successful efforts that have been made to explain matter as being simply a manifestation of electrodynamic forces (J. J. Thomson, Kaufmann, and Abraham).