

SCANNING TUNNELING MICROSCOPY - FROM BIRTH TO ADOLESCENCE

Nobel lecture, December 8, 1986

by

GERD BINNIG AND HEINRICH ROHRER

IBM Research Division, Zurich Research Laboratory, 8803 Rüschlikon,
Switzerland

We present here the historic development of Scanning Tunneling Microscopy; the physical and technical aspects have already been covered in a few recent reviews and two conference proceedings [1] and many others are expected to follow in the near future. A technical summary is given by the sequence of figures which stands alone. Our narrative is by no means a recommendation of how research should be done, it simply reflects what we thought, how we acted and what we felt. However, it would certainly be gratifying if it encouraged a more relaxed attitude towards doing science.

Perhaps we were fortunate in having common training in superconductivity, a field which radiates beauty and elegance. For scanning tunneling microscopy, we brought along some experience in tunneling [2] and angstroms [3], but none in microscopy or surface science. This probably gave us the courage and light-heartedness to start something which should "not have worked in principle" as we were so often told.

"After having worked a couple of years in the area of phase transitions and critical phenomena, and many, many years with magnetic fields, I was ready for a change. Tunneling, in one form or another had intrigued me for quite some time. Years back, I had become interested in an idea of John Slonczewski to read magnetic bubbles with tunneling; on another occasion, I had been involved for a short time with tunneling between very small metallic grains in bistable resistors, and later I watched my colleagues struggle with tolerance problems in the fabrication of Josephson junctions. So the local study of growth and electrical properties of thin insulating layers appeared to me an interesting problem, and I was given the opportunity to hire a new research staff member, Gerd Binnig, who found it interesting, too, and accepted the offer. Incidentally, Gerd and I would have missed each other, had it not been for K. Alex Müller, then head of Physics, who made the first contacts [1]."

The original idea then was not to build a microscope but rather to perform spectroscopy locally on an area less than 100 Å in diameter.

"On a house-hunting expedition, three months before my actual start at IBM, Heini Rohrer discussed with me in more detail his thoughts on inhomogeneities on surfaces, especially those of thin oxide layers grown on metal

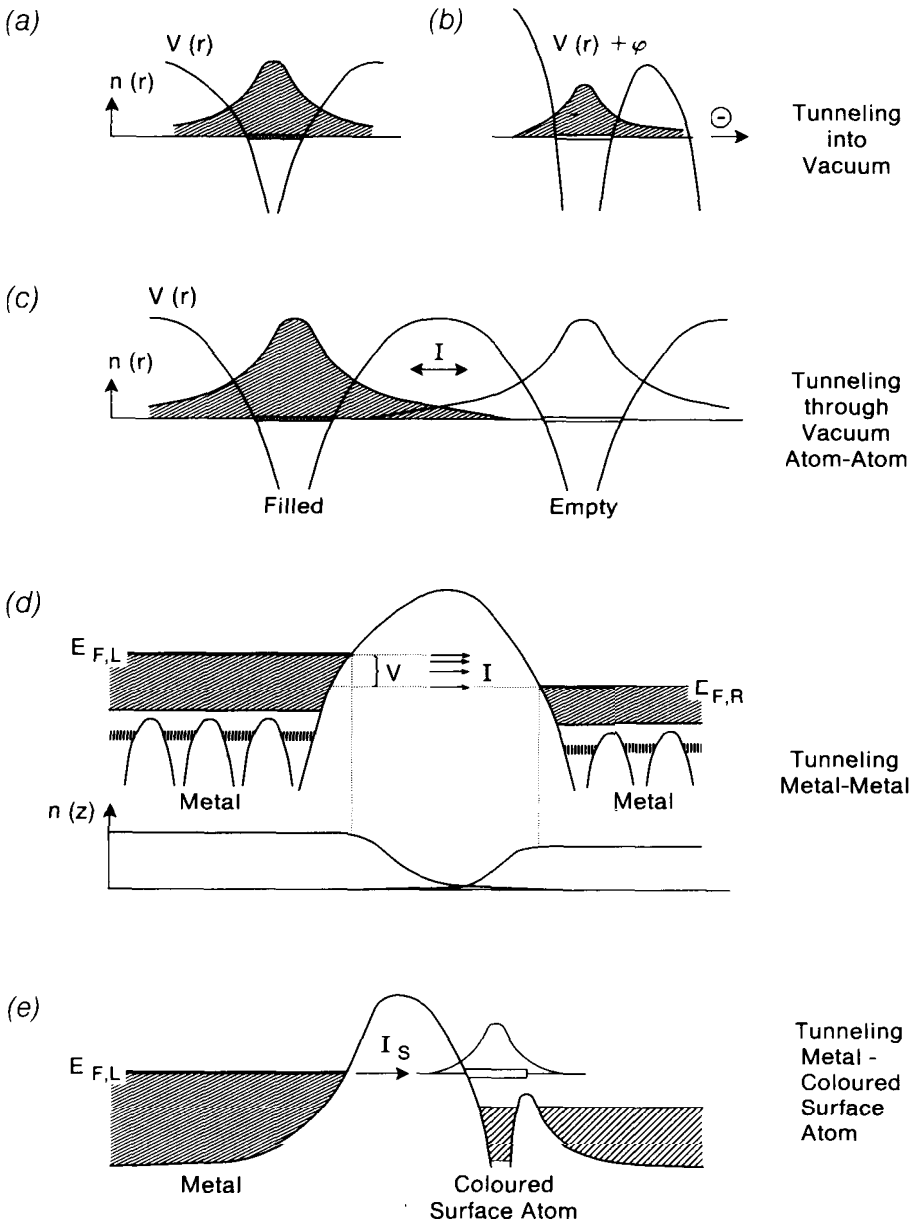
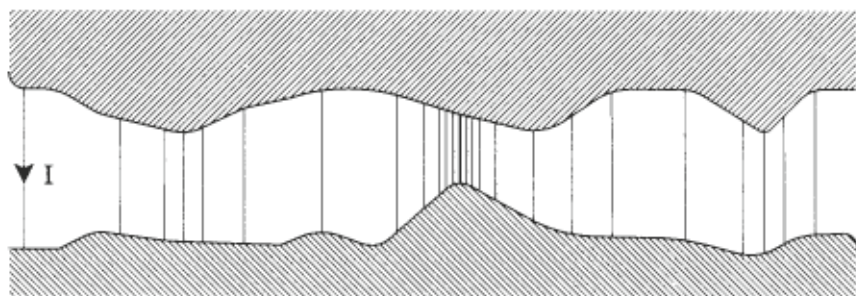

Fig. 1. Tunneling. (a) The wave function of a valence electron in the Coulomb potential well of the atom core plus other valence electrons extends into the vacuum; it "tunnels" into the vacuum. (b) Exposed to an electric field, ϕ , the electron can tunnel through the potential barrier and leaves the atom. (c) If two atoms come sufficiently close, then an electron can tunnel back and forth through the vacuum or potential barrier between them. (d) In a metal, the potential barriers between the atoms in the interior are quenched and electrons move freely in energy bands, the conduction bands. At the surface, however, the potential rises on the vacuum side forming the tunnel barrier through which an electron can tunnel to the surface atom of another metal close by. The voltage V applied between the two metals produces a difference between the Fermi levels $E_{F,L}$ and $E_{F,R}$, thus providing empty states on the right for the electrons tunneling from the left side. The

Oxide Junction



Tunnel Tip

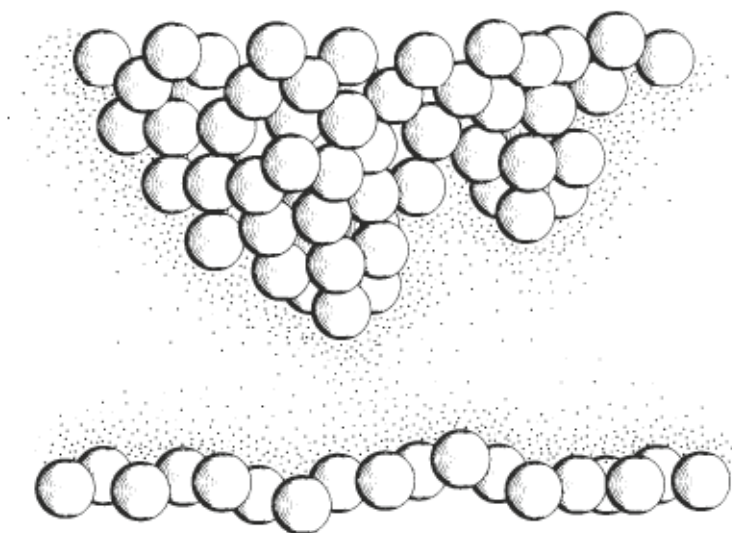

Fig. 2. The principle. The tunneling transmittivity decreases exponentially with the tunneling distance, in vacuum about a factor 10 for every Å. In an oxide tunnel junction, most of the current flows through narrow channels of small electrode separation. With one electrode shaped into a tip, the current flows practically only from the front atoms of the tip, in the best case from a specific orbital of the apex atom. This gives a tunnel-current filament width and thus a lateral resolution of atomic dimensions. The second tip shown is recessed by about two atoms and carries about a million times less current.

resulting tunnel current is roughly of the form $I = f(V) \exp(-\sqrt{\phi} s)$. The $f(V)$ contains a weighted joint local density of states of tip and object, the exponential gives the transmittivity with ϕ the averaged tunnel barrier height in eV, and s the separation of the two metals in Å. Here $f(V)$ and $\sqrt{\phi}$ are material properties obtained by measuring $d \ln I / dV$ and $d \ln I / ds$. (e) A simple case of local spectroscopy. A characteristic state, the "color", of a surface species is observed by the onset of the tunnel-current contribution $I\Sigma$, [see Lang, N. D. (1987) *Phys. Rev. Lett.* 58, 45, and references therein].

surfaces. Our discussion revolved around the idea of how to study these films locally, but we realized that an appropriate tool was lacking. We were also puzzling over whether arranging tunneling contacts in a specific manner would give more insight on the subject. As a result of that discussion, and quite out of the blue at the LT15 Conference in Grenoble - still some weeks before I actually started at IBM - an old dream of mine stirred at the back of my mind, namely, that of vacuum tunneling. I did not learn until several years later that I had shared this dream with many other scientists, who like myself, were working on tunneling spectroscopy. Strangely enough, none of us had ever talked about it, although the idea was old in principle." Actually, it was 20 years old, dating back to the very beginning of tunneling spectroscopy [4]. Apparently, it had mostly remained an idea and only shortly after we had started, did Seymour Keller, then a member of the IBM Research Division's Technical Review Board and an early advocate of tunneling as a new research area in our Laboratory, draw our attention to W.A. Thompson's attempting vacuum tunneling with a positionable tip [5].

We became very excited about this experimental challenge and the opening up of new possibilities. Astonishingly, it took us a couple of weeks to realize that not only would we have a local spectroscopic probe, but that scanning would deliver spectroscopic and even topographic images, i.e., a new type of microscope. The operating mode mostly resembled that of stylus profilometry [6], but instead of scanning a tip in mechanical contact over a surface, a small gap of a few angstroms between tip and sample is maintained and controlled by the tunnel current flowing between them. Roughly two years later and shortly before getting our first images, we learned about a paper by R. Young *et al.* [7] where they described a type of field-emission microscope they called "topogra-liner". It had much in common with our basic principle of operating the STM, except that the tip had to be rather far away from the surface, thus on high voltage producing a field-emission current rather than a tunneling current and resulting in a lateral resolution roughly that of an optical microscope. They suggested to improve the resolution by using sharper field-emission tips, even attempted vacuum tunneling, and discussed some of its exciting prospects in spectroscopy. Had they, even if only in their minds, combined vacuum tunneling with scanning, and estimated that resolution they would probably have ended up with the new concept, Scanning Tunneling Microscopy. They came closer than anyone else.

Mid-January 1979, we submitted our first patent disclosure on STM. Eric Courtens, then deputy manager of physics at the IBM R uschlikon Laboratory, pushed the disclosure to a patent application with "thousands of future STM's". He was the first believer in our cause. Shortly afterwards, following an in-house seminar on our STM ideas, Hans-J org Scheel became the third.

For the technical realization of our project, we were fortunate in securing the craftsmanship of Christoph Gerber. "Since his joining IBM in 1966, Christoph had worked with me (HR) on pulsed high-magnetic fields, on phase diagrams, and on critical phenomena. By the end of 1978, we were quite excited about our first experimental results on the random-field problem, but when asked to

participate in the new venture, Christoph did not hesitate an instant. He always liked things which were out of the ordinary, and, incidentally, was the second believer. This left me and the random-field problem without his diligent technical support. About a year later, Edi Weibel was the next one to join in, which left another project without technical support. Finally, I completed the team, leaving the random-field problem to others."

During the first few months of our work on the STM, we concentrated on the main instrumental problems and their solutions [8]. How to avoid mechanical vibrations that move tip and sample against each other? Protection against vibrations and acoustical noise by soft suspension of the microscope within a vacuum chamber. How strong are the forces between tip and sample? This seemed to be no problem in most cases. How to move a tip on such a line scale? With piezoelectric material, the link between electronics and mechanics, avoiding friction. The continuous deformation of piezomaterial in the angstrom and subangstrom range was established only later by the tunneling experiments themselves. How to move the sample on a line scale over long distances from the position of surface treatment to within reach of the tip? The 'louse'. How to avoid strong thermally excited length fluctuations of the sample and especially the tip? Avoid whiskers with small spring constants. This led to a more general question, and the most important one: What should be the shape of the tip and how to achieve it? At the very beginning, we viewed the tip as a kind of continuous matter with some radius of curvature. However, we very soon realized that a tip is never smooth because of the finite size of atoms, and because tips are quite rough unless treated in a special way. This roughness implies the existence of minitips as we called them, and the extreme sensitivity of the tunnel current on tip-sample separation then selects the minitip reaching closest to the sample.

Immediately after having obtained the first stable STM images showing remarkably sharp monoatomic steps, we focused our attention onto atomic resolution. Our hopes of achieving this goal were raised by the fact that vacuum tunneling itself provides a new tool for fabricating extremely sharp tips: The very local, high fields obtainable with vacuum tunneling at a few volts only can be used to shape the tip by field migration or by field evaporation. Gently touching the surface is another possibility. All this is not such a controlled procedure as tip sharpening in field-ion microscopy, but it appeared to us to be too complicated to combine STM with field-ion microscopy at this stage. We hardly knew what field-ion microscopy was, to say nothing of working with it. We had no means of controlling exactly the detailed shape of the tip. We repeated our trial-and-error procedures until the structures we observed became sharper and sharper. Sometimes it worked, other times it did not.

But first we had to demonstrate vacuum tunneling. In this endeavor, apart from the occurrence of whiskers, the most severe problem was building vibrations. To protect the STM unit also against acoustical noise, we installed the vibration-isolation system within the vacuum chamber. Our first set-up was designed to work at low temperatures and in ultra-high vacuum (UHV). Low

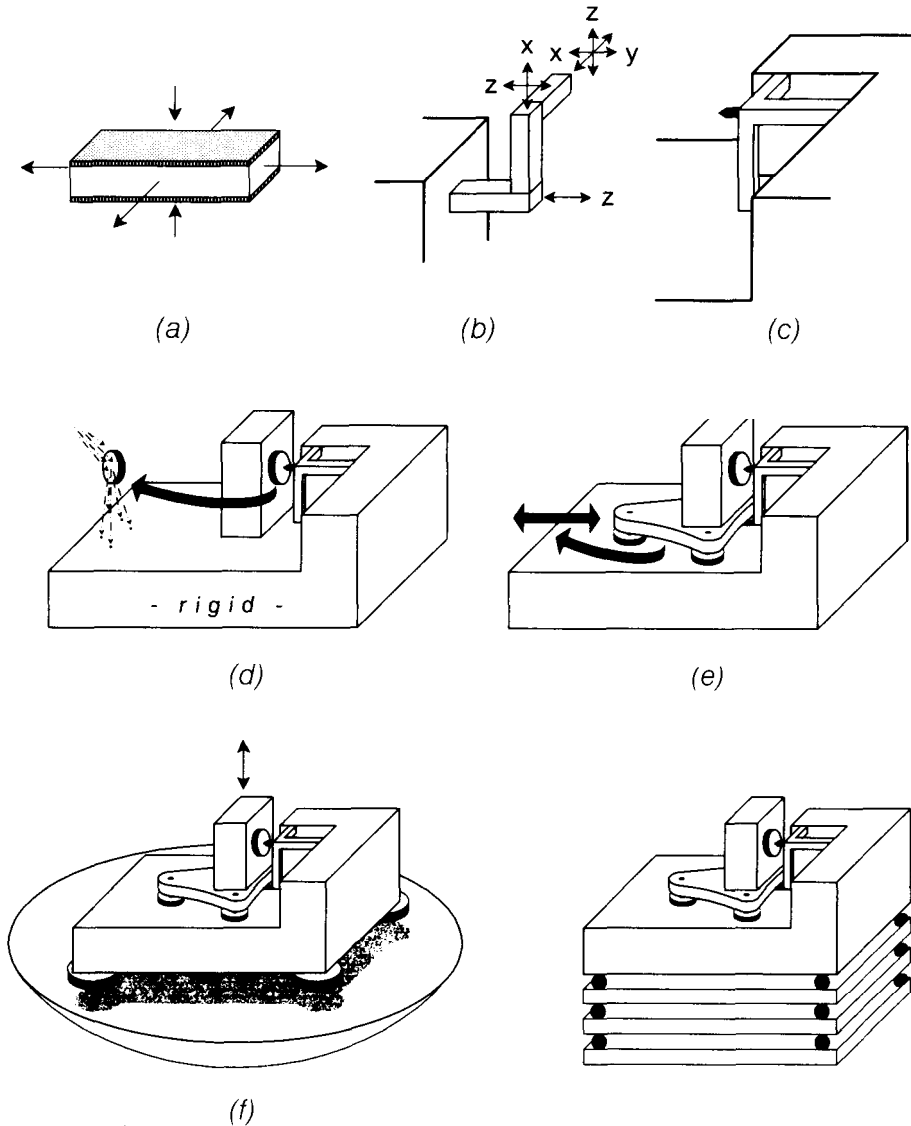

Fig. 3. The instrument. (a) A voltage applied to two electrodes contracts or expands the piezoelectric material in between. The practical total excursion of a piezo is usually in the region of micrometers. (b) A frictionless x-y-z piezodrives, which is quite vibration sensitive. (c) A rigid tripod is at present the piezodrives most used apart from the single-tube scanner. (d) Tripod and sample holder are installed on a rigid frame. The sample has to be cleared from the tip for preparation and sample transfer. (e) Positioning of the sample to within reach of the piezodrives was originally achieved with a piezoelectric 'louse' with electrostatically clampable feet. Magnetic-driven positioners and differential screws are also now in use. (f) In the first vibration-isolation system, the tunnel unit with permanent magnets levitated on a superconducting lead bowl. (g) The simple and presently widely used vibration protection with a stack of metal plates separated by viton - a UHV-compatible rubber spacer.

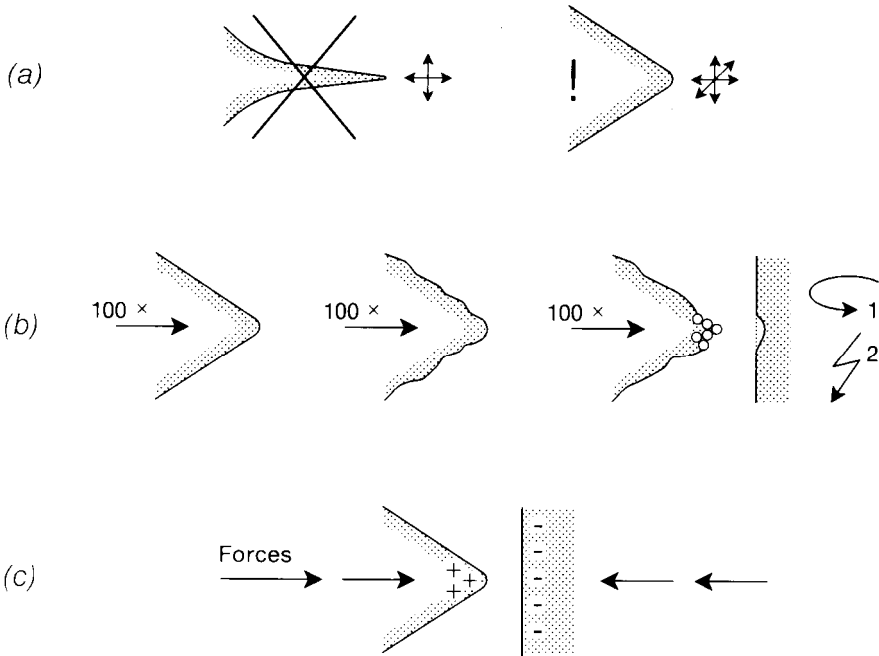
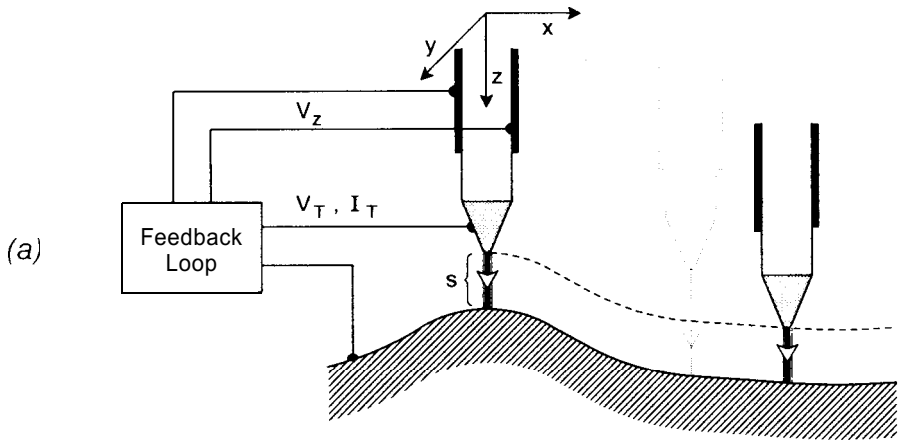

Fig. 4. Tips. (a) Long and narrow tips, or whiskers, are vibration sensitive and thermally excited. (b) A mechanically ground or etched tip shows sharp minitips, only one of which usually carries the tunnel current. Further sharpening was initially achieved with gentle contact (1), later with field evaporation (2). (c) Electrostatic and interatomic forces between tip and sample do not deform a blunt tip, or a rigid sample, but they make the tunnel gap mechanically unstable when the tip carries a whisker. The response of soft materials like graphite or organic matter to such forces, however, can be appreciable and has to be taken into account.

temperatures guaranteed low thermal drifts and low thermal length fluctuations, but we had opted for them mainly because our thoughts were fixed on spectroscopy. And tunneling spectroscopy was a low-temperature domain for both of us with a Ph.D. education in superconductivity. The UHV would allow preparation and retention of well-defined surfaces. The instrument was beautifully designed with sample and tip accessible for surface treatments and superconducting levitation of the tunneling unit for vibration isolation. Construction and first low-temperature and UHV tests took a year, but the instrument was so complicated, we never used it. We had been too ambitious, and it was only seven years later that the principal problems of a low-temperature and UHV instrument were solved [9]. Instead, we used an exsiccator as vacuum chamber, lots of Scotch tape, and a primitive version of superconducting levitation wasting about 20 l of liquid helium per hour. Emil Haupt, our expert glassblower, helped with lots of glassware and, in his enthusiasm, even made the lead bowl for the levitation. Measuring at night and hardly daring to breathe from excitement, but mainly to avoid vibrations, we obtained our first clear-cut exponential dependence of the tunnel current I on tip-sample separation s characteristic for tunneling. It was the portentous night of March 16, 1981.

Constant Current Mode



$$V_z (V_x, V_y) \rightarrow z (x, y)$$

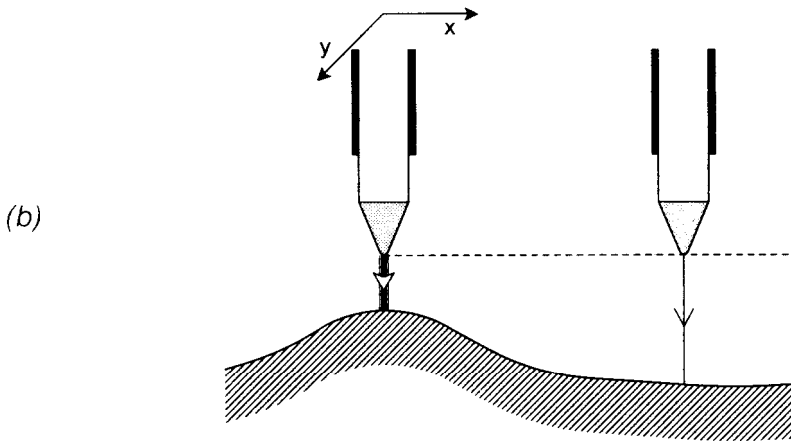

$$\ln I (V_x, V_y) \rightarrow \sqrt{\Phi} \cdot z (x, y)$$

Fig. 5. Imaging. (a) In the constant current mode, the tip is scanned across the surface at constant tunnel current, maintained at a pre-set value by continuously adjusting the vertical tip position with the feedback voltage V_z . In the case of an electronically homogeneous surface, constant current essentially means constant s . (b) On surface portions with denivellements less than a few Å-corresponding to the dynamic range of the current measurement-the tip can be rapidly scanned at constant average z -position. Such "current images" allow much faster scanning than in (a) but require a separate determination of $\sqrt{\Phi}$ to calibrate z . In both cases, the tunnel voltage and/or the z -position can be modulated to obtain in addition, $d \ln I / dV$ and/or $d \ln I / ds$, respectively.

So, 27 months after its conception the Scanning Tunneling Microscope was born. During this development period, we created and were granted the necessary elbow-room to dream, to explore, and to make and correct mistakes. We did not require extra manpower or funding, and our side activities produced acceptable and publishable results. The first document on STM was the March/April 1981 in-house Activity Report.

A logarithmic dependence of the tunnel current I on tip-sample separation s alone was not yet proof of vacuum tunneling. The slope of $\ln I$ versus s should correspond to a tunnel-barrier height of $\phi \approx 5$ eV, characteristic of the average workfunctions of tip and sample. We hardly arrived at 1 eV, indicating tunneling through some insulating material rather than through vacuum. Fortunately, the calibration of the piezosensitivity for small and fast voltage changes gave values only half of those quoted by the manufacturers. This yielded a tunnel-barrier height of more than 4 eV and thus established vacuum tunneling. This reduced piezosensitivity was later confirmed by careful calibration with H.R. Ott from the ETH, Zurich, and of S.Vieira of the Universidad Autónoma, Madrid [10].

U. Poppe had reported vacuum tunneling some months earlier [11], but his interest was tunneling spectroscopy on exotic superconductors. He was quite successful at that but did not measure $I(s)$. Eighteen months later, we were informed that E.C. Teague, in his Thesis, had already observed similar $I(s)$ curves which at that time were not commonly available in the open-literature [12].

Our excitement after that March night was quite considerable. Hirsh Cohen, then Deputy Director of our Laboratory, spontaneously asked us "What do you need?", a simple and obvious question people only rarely dare to ask. "Gerd immediately wanted to submit a post-deadline contribution [13] to the LT16 Conference to be held in Los Angeles in September. He was going there anyway with his superconducting strontium titanate, and I was sure we would have some topographic STM images by then. And indeed we had. I arranged an extended colloquium tour through the USA for Gerd, but about three weeks before his departure, a friend warned him, that once the news became public, hundreds of scientists would immediately jump onto the STM bandwagon. They did - a couple of years later. After two extended discussions on a weekend hike, he nevertheless became convinced that it was time for the STM to make its public appearance." Our first attempt to publish a letter failed. "That's a good sign", Nico Garcia, a Visiting Professor from the Universidad Autónoma de Madrid, Spain consoled us.

After this first important step with a complete STM set-up, it took us only three months, partly spent waiting for the high-voltage power supplies for the piezcs, to obtain the first images of monosteps [14] on a CaIrSn_3 single crystal grown by R. Gambino. Here, the main problem was getting rid of the whiskers we continually created by bumping the tip into the surface. Now we were ready to turn to surface science, first to resolve surface reconstructions. We built a UHV-compatible STM (no longer with Scotch tape!) and as a quick trial,

operated it in vacuum suspended from a rubber band. The results indicated that superconducting levitation might be unnecessary.

That was the state of the art for the publicity tour through the USA in September '81. Most reactions were benevolent, some enthusiastic, and two even anticipated the Nobel prize, but the STM was apparently still too exotic for any active outside engagement.

Next, we protected the STM from vibrations by a double-stage spring system with eddy-current damping [8], and incorporated it in a UHV chamber not in use at that moment. We added sputtering and annealing for sample treatment, but no other surface tool to characterize and monitor the state of the sample or tip could yet be combined with that STM. Although the superconducting levitation served for three months only, it was cited for years. It would appear that something complicated is much easier to remember!

A most intriguing and challenging surface-science problem existed, namely, the 7×7 reconstruction of the Si(111) surface. A class of fashionable models contained rather rough features which should be resolvable by the STM. So we started to chase after the 7×7 structure, and succumbed to its magic. At first, with no success. The STM would function well, sometimes with resolutions clearly around 5 \AA , but not our surface preparation. We occasionally found quite nice patterns with monolayer step lines [8] but usually the surface always looked rough and disordered on an atomic scale. One image even foreshadowed the 7×7 by a regular pattern of depressions, the precursors of the characteristic corner holes. However, a single event is too risky to make a case for a new structure obtained with a new method. But it boosted our confidence.

By spring '82, STM was already a subject talked about. Supposedly, an image of a vicinal surface expertly prepared with a regular step sequence would have eased the somewhat reserved attitude of the surface-science community. We, however, thought that the mono-, double-, and triple-steps of the CaIrSn_4 with atomically flat terraces [14] and the step lines of Si(111) [8] were convincing and promising enough. And instead of wasting further time on uninteresting step lines, we preferred to attack surface reconstructions with known periodicities and with a reasonable chance of learning and contributing something new.

For easier sample preparation and because the demand on resolution was only 8 \AA , we changed to a gold single crystal, namely, the (110) surface known to produce a 1×2 reconstruction. This seemed to be well within reach of the STM resolution from what we had learned from the silicon step lines. Although some time earlier, we had returned to Karl-Heinz Rieder, the Laboratory's surface-science expert, his Si single crystal in a kind of droplet form, it did not deter him from proposing this gold experiment which meant lending us his Au crystal, and some weeks later we added another droplet to his collection! But in between, with his advice on surface preparation, we succeeded in resolving the 1×2 structure [15]. Contrary to expectations, we also had to struggle with resolution, because Au transferred from the surface even if we only touched it gently with our tip. The mobility of Au at room temperature is so high that rough surfaces smooth out after a while, i. e., really sharp Au-coated tips cease

to exist. We should like to mention here that later, for measurements on Au(100), we formed sharp Au tips by field evaporation of Au atoms from sample to tip, and could stabilize them by a relatively high field resulting from a 0.8 V tunnel voltage.

In the case of the Au(110) surface, the atomic resolution was rather a matter of good luck and perseverance. It jumped from high to low in an unpredictable manner, which was probably caused by migrating adatoms on the tip finding a stable position at the apex for a while. We also observed an appreciable disorder leading to long but narrow ribbons of the 1×2 reconstruction mixed with ribbons of 1×3 and 1×4 reconstructions and step lines. Nevertheless, these experiments were the first STM images showing atomic rows with atomic resolution perpendicular to the rows. The disorder, intrinsic on this surface, but in its extent criticized from the surface-science point of view, demonstrated very nicely the power of STM as a local method, and about a year later played an important role in testing the first microscopic theories of scanning tunneling microscopy.

With gold, we also performed the first spectroscopy experiment with an STM. We wanted to test a prediction regarding the rectifying I-V characteristic of a sample-tip tunnel junction induced by the geometric asymmetry [16]. Unfortunately, the sample surface became unstable at around 5 V, sample positive, and the small asymmetry observed in this voltage range could also have been due to other reasons. But with reversed polarity, the voltage could be swept up to 20 V producing a whole series of marked resonant surface states [8]. We consider the gold exercise during spring and early summer of '82 a most important step in the development of the method, and the STM had already exceeded our initial expectations. We had also won our first believers outside the Laboratory, Cal Quate from Stanford University [17] and Paul Hansma from the University of California at Santa Barbara [18]. We gave numerous talks on the Au work, and it attracted some attention but all in all, there was little action. We did not even take the time to write a paper - the 7×7 was waiting!

Meanwhile, we had also made the first attempts at chemical imaging: Small Au islands on silicon. The islands were visible as smooth, flat hills on a rough surface in the topography, but they were also clearly recognizable as regions with enhanced tunnel-barrier height [8]. Thus, the Au islands were imaged thanks to their different surface electronic properties. It would certainly have been interesting to pursue this line, but we knew that, in principle, it worked, - and the 7×7 was still waiting!

We started the second 7×7 attempt in autumn 1982 taking into consideration the advice of Franz Himpsel not to sputter the surface. This immediately worked and we observed the 7×7 wherever the surface was flat. We were absolutely enchanted by the beauty of the pattern.

"I could not stop looking at the images. It was like entering a new world. This appeared to me as the unsurpassable highlight of my scientific career and therefore in a way its end. Heini realized my mood and whisked me away for

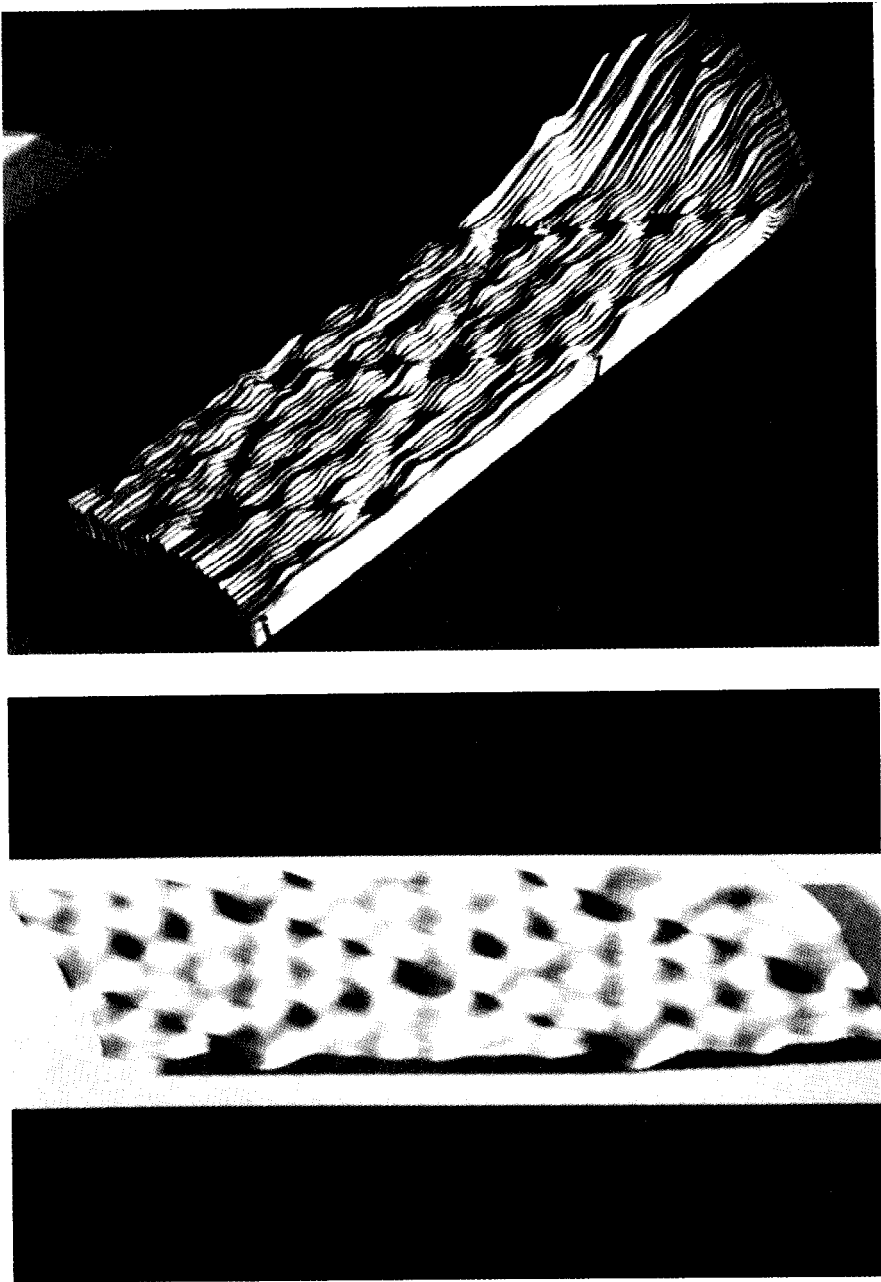

Fig. 6. 7×7 reconstruction of Si(111), (a) Relief assembled from the original recorder traces, from Ref. [19], © 1983 The American Physical Society, and (b) processed image of the 7×7 reconstruction of Si(111). Characteristic of the rhombohedral surface unit cell are the corner hole and the 12 maxima, the adatoms. In the processed image, the six adatoms in the right half of the rhombi appear higher. This is an electronic inequivalence on the surface owing to a structural left-right inequivalence in the underlying layers. The reconstruction extends undisturbed to the immediate vicinity of the large "atom hill" on the right.

some days to St. Antonien, a charming village high up in the Swiss mountains, where we wrote the paper on the 7×7 ."

We returned convinced that this would attract the attention of our colleagues, even of those not involved with surface science. We helped by presenting both an unprocessed relief model assembled from the original recorder traces with scissors, Plexiglass and nails, and a processed top view; the former for credibility, the latter for analysis and discussion [19]. It certainly did help, with the result that we practically stopped doing research for a while. We were inundated with requests for talks, and innumerable visitors to our Laboratory were curious to know how to build an STM. However, the number of groups that seriously got started remained small. It seemed there was still a conflict between the very appealing, conceptual easiness of displaying individual atoms in three-dimensional real space direct by recorder traces, and the intuitive reservation that, after all, it just could not be that simple.

Our result excluded all the numerous models that existed, and strangely enough also some that followed. Only one came very close: The adatom model by W. Harrison [20] with just the number of adatoms not quite right. Nowadays, a variation of the adatom model where deeper layers are also reconstructed besides the characteristic 7×7 adatom pattern [21], is generally accepted and compatible with most results obtained by various experimental methods like ion channeling [22], transmission electron diffraction [23], and more detailed STM results from other groups [24].

The 7×7 experiments also accelerated the first theoretical efforts of STM on a microscopic level. Tersoff and Hamman, and Baratoff [25] applied Bardeen's transfer Hamiltonian formalism to the small geometries of tip and an atomically corrugated surface. Garcia, Ocal, and Flores, and Stoll, Baratoff, Selloni, and Carnevali worked out a scattering approach [26]. The two approaches converged; they consoled us by roughly confirming our intuitive view on tunneling in small geometries by simply scaling down planar tunneling, and they certainly improved the acceptance of STM in physics circles. The theoretical treatments concentrated on the nonplanar aspect of tunneling of free electrons, and the STM results on Au(110), still unpublished, served as a testing ground. They remained unpublished for quite some time, since the flashy images of the 7×7 silicon surface somehow overshadowed the earlier Au(110) experiments. One reaction to the first attempt to publish them was: "... The paper is virtually devoid of conceptual discussion let alone conceptual novelty... I am interested in the behavior of the surface structure of gold and the other metals in the paper. Why should I be excited about the results in this paper?..." It was certainly bad publication management on our part, but we were not sufficiently familiar with a type of refereeing which searches for weak points, innocently ignoring the essence.

The gold and silicon experiments showed that STM in surface science would benefit greatly from additional, in-situ surface characterization, in particular low-energy electron diffraction (LEED). We had already learned that surfaces, even elaborately prepared, were frequently not as uniform and flat as generally assumed. The in-situ combination of LEED with STM proved extremely

helpful, avoiding searching when there was nothing to be searched, and it gave us the opportunity to learn about and work with LEED and Auger electron spectroscopy (AES). The combination of STM with other established surface-science techniques also settled a concern frequently mentioned: How much did our STM images really have in common with surfaces characterized otherwise? We did not share this concern to such a degree, as we had also learned that reconstructions extended unchanged to the immediate vicinity of defect areas, and because we could detect most contaminants or defects individually. Thus, for us, the combined instrumentation was more a practical than a scientific issue.

After a short but interesting excursion with the new STM/LEED/AES combination into resolving and understanding the (100) surface of Au [27], we proceeded into the realms of chemistry. Together with A. Baró, a Visiting Professor from Universidad Autónoma de Madrid, Spain, who also wanted to familiarize himself with the technique, we observed the oxygen-induced 2×1 reconstruction of Ni(110) [28], interpreting the pronounced and regularly arranged protrusions we saw as individual oxygen atoms. We had seen atomic-scale features before, which could be interpreted as adsorbates or adsorbate clusters but they were more a nuisance than a matter of interest. The oxygen on Ni experiments demonstrated that the oxygen overlayer was not irreversibly changed by the imaging tunnel tip. This was a most significant result in regard to observing, studying and performing surface chemistry with an STM tip. About a year later, when studying the oxygen-induced 2×2 reconstructed Ni(100) surface, we observed characteristic current spikes which we could attribute to oxygen diffusing along the surface underneath the tip [29]. We noted that the same type of spikes had already been present in our earlier images of oxygen-covered Ni(110), but had been discarded at that time. Not only could diffusing atoms be observed individually, but their migration could be correlated to specific surface features like step lines or bound oxygen atoms, imaged simultaneously. Towards the end of 1983, we also started to probe the possibilities of STM in biology together with H. Gross from the ETH, Zurich. We could follow DNA chains lying on a carbon film deposited on a Ag-coated Si wafer [30].

That year ended with a most pleasant surprise: On Friday December 9, we received a telegram from the secretary of the King Faisal Foundation, followed on Monday by a phone call from the secretary of the European Physical Society announcing the King Faisal Prize of Science and the Hewlett Packard Europhysics Prize, respectively. "The day the telegram arrived, Gerd was in Berlin delivering the Otto Klung Prize lecture. It was also my twentieth anniversary with IBM." This was an encouraging sign that Scanning Tunneling Microscopy was going to make it. It also brought a new flood of requests.

In the summer of 1984, we were finally ready to assume what we had set out to do in autumn 1978, before the notion of microscopy had ever evolved, namely, performing local spectroscopy. Together with H. Fuchs and F. Salvan, we investigated the clean 7×7 [1, 3 1] and the $\sqrt{3} \times \sqrt{3}$ Au reconstructions on Si(111) [31], and-right back to the heart of the matter-a thin oxide film on Ni

[1,32]. We could see that surfaces are electronically structured as known, for example, from photoemission experiments, and that we could resolve these electronic structures in space on an atomic scale. We called this (and still do) the color of the atoms. Indeed, the oxide layers were inhomogeneous and most clearly visible in scanning tunneling spectroscopy (STS) images. On the 7×7 , we could see by STS down to the second layer, and observe individual dangling bonds between the adatoms [1]. At that time, C. Quate and his group already had an STM running, and they had performed local spectroscopy; not yet with atomic resolution but a low temperature [33]. They had measured the energy gap of a superconductor, and later even plotted its spatial dependence. Spectroscopic imaging was not really surprising, yet it was an important development. We now had the tools to fully characterize a surface in terms of topographic and electronic structure. Although it is usually quite an involved problem to separate the property of interest from a set of STM and STS measurements, our vision of the scanning tunneling microscope had become true. But nevertheless, we heard that this view was not generally shared. Rumors reached us that scientists would bet cases of champagne that our results were mere computer simulations! The bets were probably based on the fact the STM was already three years old, and atomic resolution was still our exclusive property. This was also our concern, but in another way. In late summer '83, Herb Budd, promoter of the IBM Europe Institute and an enthusiastic STM supporter, had asked us to run an STM Seminar in summer 1984 within the framework of the Institute. This meant one week with 23 lectures in front of a selected audience of the European academia. At that time, there was no way whatsoever of filling 23 hours, let alone of committing 23 speakers. A year later, we agreed, full of optimism for summer '85. In December '84, on Cal Quate's initiative, nine representatives of the most advanced STM groups came together for a miniworkshop in a hotel room in Cancun. It was a most refreshing exchange of ideas, but there was still no other atomic resolution, and thus not a sufficient number of lectures in sight for the Seminar.

In the following few months, the situation changed drastically. R. Feenstra and coworkers came up first with cleaved GaAs [34], C.F. Quate's group with the 1×1 structure on Pt(100) [35], and J. Behm, W. Hoesler, and E. Ritter with the hexagonal phase on Pt(100) [36]. At the American Physical Society March Meeting in 1985, P. Hansma presented STM images of graphite structures of atomic dimensions [37], and when J. Golovchenko unveiled the beautiful results on the various reconstructions of Ge films deposited on Si(111) [38], one could have heard a pin drop in the audience. The atomic resolution was official and scanning tunneling microscopy accepted. The IBM Europe Institute Seminar in July turned into an exclusive workshop for STM'ers, and comprised some 35 original contributions, not all of them on atomic resolution, but already more than in March [39]. "A watershed of ideas" as Cal Quate expressed it.

Our story so far has dealt mainly with the striving for structural and electronic imaging in a surface-science environment with atomic resolution.

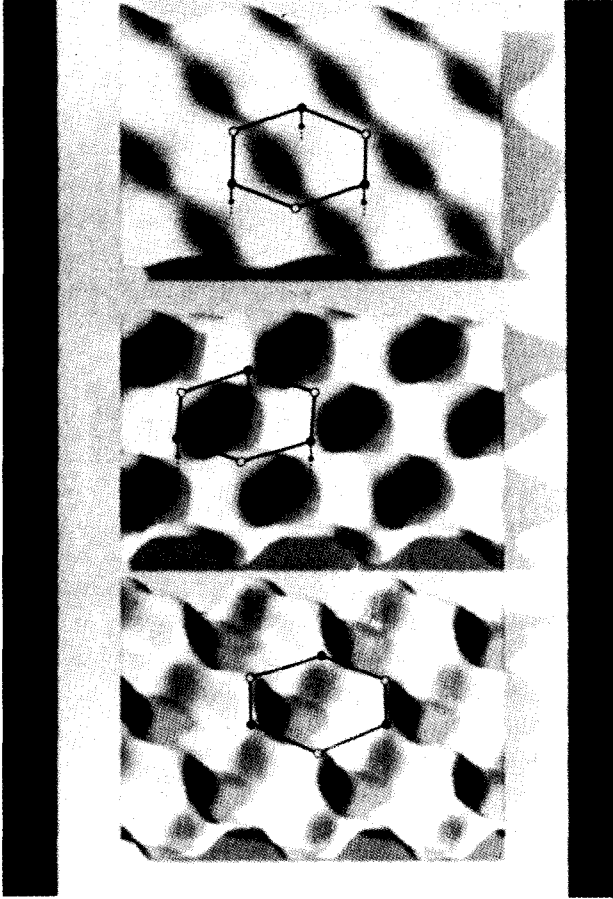

Fig. 7. STM image of cleaved graphite. The top image was taken at a constant tunnel current of 1 nA and at 50 mV. The corrugation traced by the tip reflects the local density of states (LDOS) at the Fermi level and *not* the positions of atoms, which form a flat honeycomb lattice as indicated. The LDOS at the atoms bound to the neighbors in the second layer (open circles) is lower than at the "free" atoms. The image is thus rather a spectroscopic than a topographic one. The middle image is a "current image" showing essentially the same pattern. In the bottom current image, taken closer to the surface, the two inequivalent atoms appear practically identical. This peculiar behavior is compatible with a different local elastic response of the two types of carbon atoms to the interatomic force exerted by the tip compensating for their different LDOS. A local perturbation of the electronic structure might also be important.

Individual atoms had been seen before with field-ion microscopy, and dealt with individually by the atom probe technique [40]. The beauty of these techniques is relativized by the restriction to distinct atom sites on fine tips made from a rather limited selection of materials. Similarly, electron microscopy, the main source of present-day knowledge on submicron structures in practically all areas of science, technology, and industry, has advanced to the atomic level. Imaging of individual atoms or atomic structures, however, is still reserved for specific problems, expertise, and extraordinary equipment. The appeal and the impact of STM lie not only in the observation of surfaces atom by atom, but also in its widespread applicability, its conceptual and instrumental simplicity and its affordability, all of which have resulted in a relaxed and almost casual perception of atoms and atomic structures.

But there are many other aspects, maybe less spectacular but nonetheless significant, which have made STM an accepted and viable method now pursued in many areas of science and technology.

The instruments themselves have become simpler and smaller. Their greatly reduced size allows easy incorporation into other systems, for instance, into a scanning electron microscope [41]. One type of instrument retains accurate sample positioning but is sufficiently rigid for in-situ sample and tip exchange. Other instruments are so rigid they are even insensitive to vibrations when immersed in liquid nitrogen [42], and even small enough to fit through the neck of a liquid-helium storage vessel [43]. These humming-birds of STM, some concepts of which reach back to the squeezable tunnel junctions [18], can also operate at television speed on relatively flat surfaces using single-tube scanners [43, 44]. Also tip preparation has advanced to a level where well-defined pyramidal tips ending with one [45] or more [46] atoms can be fabricated in a UHV environment. Such tips are particularly important for investigations of nonperiodic structures, disordered systems and rough surfaces. They are also interesting in their own right, for example, as low-energy electron and ion point sources.

Outside the physics and surface-science communities, the various imaging environments and imaging capabilities seem as appealing as atomic resolution. Images obtained at ambient-air pressure were first reported in 1984 [47], followed by imaging in cryogenic liquids [42], under distilled water [48], in saline solutions [48], and in electrolytes [49]. Scanning tunneling potentiometry appears to have become an interesting technique to study the potential distribution on an atomic scale of current-carrying microstructures [50]. More recent advances include interatomic-force imaging with the atomic-force microscope [51], with which the structure and elastic properties of conductors and insulators are obtained, and combined imaging of electronic and elastic properties of soft materials [52]. Also the use of spin polarized electron tunneling to resolve magnetic surface structures is being explored.

Finally, we revert to the point where the STM originated: The performance of a local experiment, at a preselected position and on a very small spatial scale down to atomic dimensions. Besides imaging, it opens, quite generally, new possibilities for experimenting, whether to study nondestructively or to modify

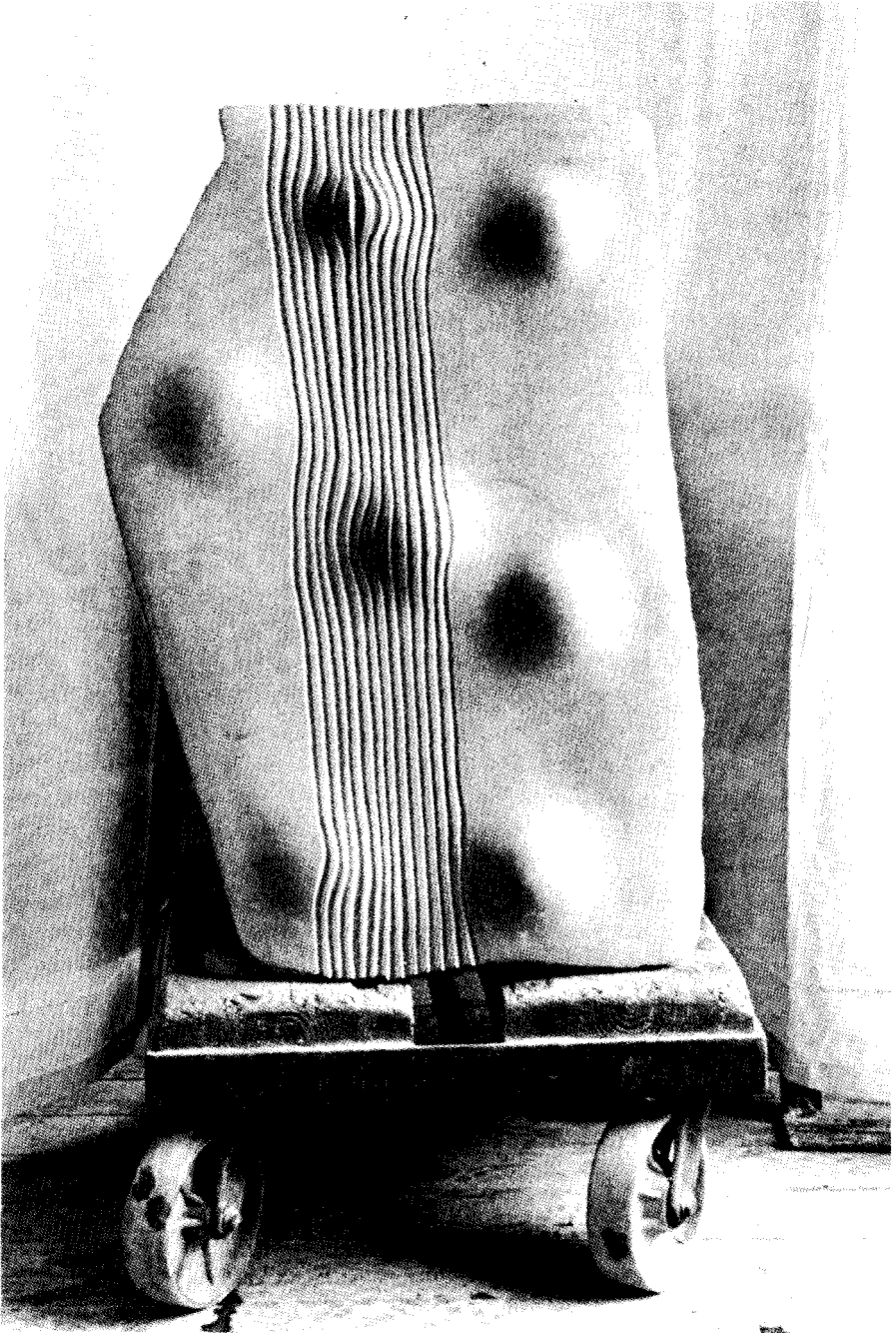

Fig. 8. Artist's conception of spheres. Art and Science are both products of the creativity of Man, and the beauty of nature is reflected in both. Ruedi Rempfler, the sculptor, found his interpretation in the deformation of a surface. It was the tension of the sphere in its environment which fascinated him, more than the mere portrayal of its shape. An independent creation, its visual and conceptual similarity with Fig. 6 is astounding. Original sculpture by Ruedi Rempfler, photograph courtesy of Thomas P. Frey.

locally: Local high electric fields, extreme current densities, local deformations, measurements of small forces down to those between individual atoms, just to name a few, ultimately to handle atoms [53] and to modify individual molecules, in short, to use the STM as a Feynman Machine [54]. This area has not yet reached adolescence.

The STM's "Years of Apprenticeship" have come to an end, the fundamentals have been laid, and the "Years of Travel" begin. We should not like to speculate where it will finally lead, but we sincerely trust that the beauty of atomic structures might be an inducement to apply the technique to those problems where it will be of greatest service solely to the benefit of mankind. Alfred Nobel's hope, our hope, everybody's hope.

ACKNOWLEDGEMENT

We should like to thank all those who have supported us in one way or another, and those who have contributed to the development of Scanning Tunneling Microscopy, and express our appreciation of the pleasant and collegial atmosphere existing in the STM community. Thanks are also due to Dilys Brüllmann for her diligent handling of our manuscripts from the start and for her careful reading of this manuscript, and to Erich Stoll for processing Figs. 6 and 7 using ideas of R. Voss.

REFERENCES

- [1] For reviews, see Binnig, G., and Rohrer, H. (1986) *IBM J. Res. Develop.* 30, 355; Golovchenko, J. A. (1986) *Science* 232, 48; Behm, R. J., and Hoesler, W. (1986) *Physics and Chemistry of Solid Surfaces*, Vol VI, (Springer Verlag, Berlin), p. 361; Hansma, P. K., and Tersoff, J. (1987) *J. Appl. Phys.* 61, R1; Proceedings of the STM Workshops in Oberlech, Austria, July 1-5, 1985, *IBM J. Res. Develop.* 30, Nos. 4 and 5 (1986); Proceedings of STM '86, Santiago de Compostela, Spain, July 14- 18, 1986, *Surface Sci.*, 181, Nos. 1 and 2 (1987). An article combining technical and biographical details is presented in Dordick, Rowan L. (1986) *IBM Research Magazine* 24, 2.
- [2] Binnig, G. K., and Hoening, H. E. (1978) *Z. Phys. B* 32, 23.
- [3] Rohrer, H. (1960) *Helv. Phys. Acta* 33, 675.
- [4] Giaever, I. (1974) *Rev. Mod. Phys.* 46, 245.
- [5] Thompson W. A., and Hanrahan, S. F. (1976) *Rev. Sci. Instrum.* 47, 1303.
- [6] Williamson, B. P. (1967) *Proc. Inst. Mech. Eng.* 182,21; Guenther, K. H., Wierer, P. G., and Bennett, J. M. (1984) *Appl. Optics* 23, 3820.
- [7] Young, R., Ward, J., and Scire, F. (1972) *Rev. Sci. Instrum.* 43, 999.
- [8] For technical details, see Binnig, G., and Rohrer, H. (1982) *Helv. Phys. Acta* 5.5, 726; *idem* (1983) *Surface Sci.* 126, 236; *idem* (1985) *Sci. Amer.* 253, 50.
- [9] Marti, O. (1986) Ph.D. Thesis No. 8095, ETH Zurich, Switzerland; Marti, O., Binnig, G., Rohrer, H., Salemink, H., (1987) *Surface Sci.*, 181, 230.
- [10] Ott, H. R., and Rohrer, H. (1981) unpublished; Vierira, S. (1986) *IBM J. Res. Develop.* 30, 553.
- [11] Poppe, U. (1981) *Verhandl. DPG (VI)* 16, 476.
- [12] Teague, E. C. (1978) Dissertation, North Texas State Univ., Univ. Microfilms International, Ann Arbor, Mich., p. 141; *idem* (1978) *Bull. Amer. Phys. Soc.* 23, 290; *idem* (1986) *J. Res. Natl. Bur. Stand.* 91, 171.
- [13] Binnig, G., Rohrer, H., Gerber, Ch., and Weibel, E. (1982) *Physica B* 109 & 110, 2075.
- [14] Binnig, G., Rohrer, H., Gerber, Ch., and Weibel, E. (1982) *Phys. Rev. Lett.* 49,57.
- [15] Binnig, G., Rohrer, H., Gerber, Ch., and Weibel, E. (1983) *Surface Sci.* 131, L379.
- [16] Miskowsky, N. M., Cutler, P. H., Feuchtwang, T. E. Shepherd, S. J., Lucas, A. A., and Sullivan, T. E. (1980) *Appl. Phys. Lett.* 37, 189.
- [17] Quate, C. F. (1986) *Physics Today* 39, 26.
- [18] Moreland, J., Alexander, S., Cox, M., Sonnenfeld, R., and Hansma, P. K. (1983) *Appl. Phys. Lett.* 43, 387. Actually, Paul Hansma was indisposed and could not attend the first seminar given on STM in the USA. However, his students attended, and with them Paul built the squeezable tunnel junction.
- [19] Binnig, G., Rohrer, H., Gerber, Ch., and Weibel, E. (1983) *Phys. Rev. Lett.* 50, 120.
- [20] Harrison, W. A. (1976) *Surface Sci.* 55, 1.
- [21] Takayanagi, K., Tanishiro, Y., Takahashi, M., and Takahashi, S. (1985) *J. Vac. Sci. Tech. A* 3, 1502.
- [22] Tromp, R. M., and van Loenen, E. J. (1985) *Surface Sci.* 155,441.
- [23] Tromp, R. M. (1985) *Surface Sci.* 155, 432, and references therein.
- [24] Becker, R. S., Golovchenko, J. A., McRae, E. G., and Swartzentruber, B. S. (1985) *Phys. Rev. Lett.* 55, 2028; Hamers, R. J., Tromp, R. M., and Demuth, J. E. (1986) *Phys. Rev. Lett.* 56, 1972.
- [25] Tersoff, J., and Hamann, D. R. (1983) *Phys. Rev. Lett.* 50, 1998; Baratoff, A. (1984) *Physica* 127B, 143.
- [26] Garcia, N., Ocal, C., and Flores, F. (1983) *Phys. Rev. Lett.* 50, 2002; Stoll, E., Baratoff, A., Selloni, A., and Carnevali, P. (1984) *J. Phys. C* 17, 3073.
- [27] Binnig, G., Rohrer, H., Gerber, Ch., and Stoll, E. (1984) *Surface Sci.* 144, 321.

- [28] Baró, A. M., Binnig, G., Rohrer, H., **Gerber**, Ch., Stoll, E., Baratoff, A., and Salvan, F. (1984) Phys. Rev. Lett. 52, 1304.
- [29] Binnig, G., Fuchs, H., and Stoll, E. (1986) Surface Sci., **169**, L295.
- [30] Binnig, G., and Rohrer, H. (1984) *Trends in Physics*, editors, J. Janta and J. Pantoflíček (European Physical Society) p. 38.
- [31] Baratoff, A., Binnig, G., Fuchs, H., Salvan, F., and Stoll, E. (1986) Surface Sci., **168**, 734.
- [32] Binnig, G., Frank, K. H., Fuchs, H., Garcia, N., Reihl, B., Rohrer, H., Salvan, F., and Williams, A. R. (1985) Phys. Rev. Lett. 55, 991; Garcia, R., Saenz, J. J., and Garcia, N. (1986) Phys. Rev. B 33, 4439.
- [33] de Lozanne, A. L., Elrod, S. A., and Quate, C. F. (1985) Phys. Rev. Lett. 54, 2433.
- [34] Feenstra, R. M., and Fein, A. P. (1985) Phys. Rev. B 32, 1394.
- [35] Elrod, S. A., Bryant, A., de Lozanne, A. L., Park, S., Smith, D., and **Quate**, C. F. (1986) IBM J. Res. Develop. 30, 387.
- [36] Behm, R. J., Hoesler, W., Ritter, E., and Binnig, G. (1986) Phys. Rev. Lett. 56, 228.
- [37] Hansma, P. K. (1985) Bull. Amer. Phys. Soc. 30, 251.
- [38] Becker, R. S., Golovchenko, J. A., and Swartzentruber, B. S. (1985) Phys. Rev. Lett. 54, 2678.
- [39] Proceedings published (1986) IBM J. Res. Develop. 30, 4/5.
- [40] For a review, see Ernst, N., and Ehrlich, G. (1986) *Topics in Current Physics*, Vol. 40, editor U. Gonser (Springer Verlag, Berlin) p. 75.
- [41] Gerber, Ch., Binnig, G., Fuchs, H., Marti, O., and Rohrer, H. (1986) Rev. Sci. Instrum. 57, 221.
- [42] Coleman, R. V., Drake, B., Hansma, P. K., and Slough, G. (1985) Phys. Rev. Lett. 55, 394.
- [43] Smith, D. P. E., and Binnig, G. (1986) Rev. Sci. Instrum. 57, 2630.
- [44] Bryant, A., Smith, D. P. E., and Quate, C. F. (1986) Appl. Phys. Lett. 48, 832.
- [45] Fink, H.-W., (1986) IBM J. Res. Develop. 30,460.
- [46] Kuk, Y., and Silverman, P. J. (1986) Appl. Phys. Lett. 48, 1597.
- [47] Baró, A. M., Miranda, R., Alaman, J., Garcia, N., Binnig, G., Rohrer, H., Gerber, Ch., and Carrascosa, J. L. (1985) Nature 315, 253.
- [48] Sonnenfeld, R., and Hansma, P. K. (1986) Science 232, 211.
- [49] Sonnenfeld, R., and Schardt, B. C. (1986) Appl. Phys. Lett. 49, 1172.
- [50] Murali, P., and Pohl, D. W'. (1986) Appl. Phys. Lett. 48, 514.
- [51] Binnig, G., Quate, C. F., and Gerber, Ch. (1986) Phys. Rev. Lett. 56,930.
- [52] Soler, J. M., Baró, A. M., Garcia, N., and Rohrer, H. (1986) Phys. Rev. Lett. 57, 444; Dürig, U., Gimzewski, J. K., and Pohl, D. W. (1986) Phys. Rev. Lett. 57, 2403.
- [53] Becker, R. S., Golovchenko, J. A., and Swartzentruber, B. S. (1987) Nature 325, 419.
- [54] Feynman, R. P. (1960) Engr. and Sci., 22, February; Hameroff, S., Schneiker, C., Scott, A., Jablonka, P., Hensen, T., Sarid, D., and Bell, S. (1987).